

FLEXIGRIP® FRICTION CATCH

Amerock

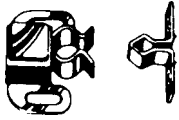

- Size: 1-5/16"L x 3/4"W x 5/8"H.
- Steel.

ORDER #	FINISH	PKG.	UNIT
BP3471-2G	ZINC	25	EACH

HEAVY DUTY FLEXA® DOOR CATCH

Bainbridge

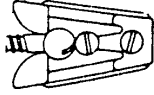

- Nylon with stainless steel spring clip.
- Super strength, for warped or large doors.
- Toddler proof.
- Packaged complete with strike & screws.

ORDER #	FINISH	PKG.	UNIT
22W-12	WHITE	25	EACH

ROLLER CATCH

Amerock



- Size: 1-5/16"L x 1-1/16"W x 5/8"H.
- Steel - polyethylene rollers.
- Spring cushioned.

ORDER #	FINISH	PKG.	UNIT
BP3472-2G	ZINC	25	EACH

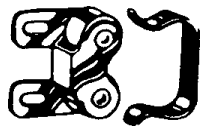

- Size: 1"L x 15/16"W x 1/2"H.
- Steel strike: 1"L x 11/16"W x 3/8"H.

ORDER #	FINISH	PKG.	UNIT
BP3474-14	NICKEL	25	EACH

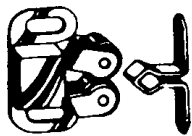

- Size: 1-5/16"L x 1-1/16"W x 5/8"H.
- Spring cushioned.

ORDER #	FINISH	PKG.	UNIT
BP9714-2G	ZINC	25	EACH

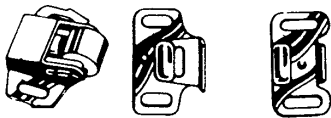

- Size: 1-3/4"L x 1-1/4"W x 3/8"H.
- Spring cushioned roller.

ORDER #	FINISH	PKG.	UNIT
BP9823-2G	ZINC	25	EACH

EZ FLEX® ELBOW CATCH

Amerock

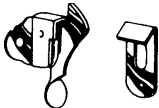

- Size: 1-5/16"L x 1"W x 1/2"H.
- Strike: 1"L x 7/16"W x 1/4"H.
- Steel.
- 2/pkg.

ORDER #	FINISH	PKG.	UNIT
BP3675-2G	ZINC	25	PKG.

ELBOW CATCH

IVES



- Base: 1-3/8" x 5/8".
- Strike: 13/16" x 5/8".

ORDER #	FINISH	PKG.	UNIT
2A92	ALUM.	25	EACH

**New items are always being added.
Please call us if you need an item not listed.**

SPRING LOADED ELBOW CATCH

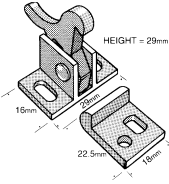

- Solid brass.
- Spring loaded.

ORDER #	FINISH	PKG.	UNIT
1018-B	BRASS	1	EACH
1018-N	NICKEL	1	EACH



TOUCH LATCH

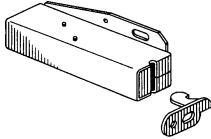

- Excellent for moderate to light weight cabinet doors.
- Zinc plated, includes screws.

ORDER #	FINISH	PKG.	UNIT
266	ZINC	10	EACH



MAGNETIC CATCHES



- Size: 2"L x 1-1/8"W x 1/2"H.
- Steel strike: 1"L x 3/4"W x 1/16"H.
- Plastic case.
- Spring cushioned.

ORDER #	FINISH	PKG.	UNIT
BP3473-PT	TAN	25	EACH

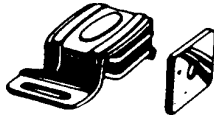

- Size: 1-15/16"L x 1-1/8"W x 9/16"H.
- Strike: 1-1/8"L x 3/4"W.
- Woodgrain aluminum case.

ORDER #	FINISH	PKG.	UNIT
BP9753-AW	WOODGRN.	25	EACH

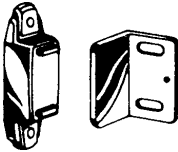

- Size: 1-15/16"L x 11/16"W.
- Strike: 1-1/8"L x 7/8"W x 3/4"H.
- Plastic case.

ORDER #	FINISH	PKG.	UNIT
BP9765-3PT	TAN	25	EACH

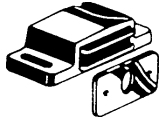

- Size: 2"L x 3/4"W x 1/2"H.
- Strike: 1-1/8"L x 3/4"W.
- Plastic case.
- Spring cushioned.

ORDER #	FINISH	PKG.	UNIT
BP9793-PT	TAN	25	EACH

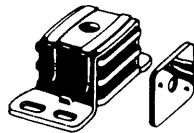

- Size: 2-1/32"L x 1-1/16"W x 13/16"H.
- Strike: 1"L x 3/4"W.
- Woodgrain aluminum case.
- Heavy duty magnetic catch.

ORDER #	FINISH	PKG.	UNIT
BP9798-AW	WOODGRN.	25	EACH



- Size: 2"L x 15/16"W x 31/64"H.
- Strike: 1-1/8"L x 13/16"H.
- Self-aligning plastic case.
- Lifetime magnet.

ORDER #	FINISH	PKG.	UNIT
1000-WH	WHITE	1	EACH



- FOR INSET DOORS

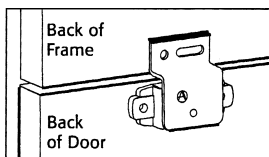

- Tenite® case.
- Size: 1-15/16"L x 3/4"W x 11/16"H.
- Strike: steel, 1-1/8"L x 1/2"D x 1-1/2"H.
- Screws: (4) #6 T.H. x 1/2".

ORDER #	FINISH	PKG.	UNIT
CM9765F-PT	TAN	25	EACH



MAGNETIC SINGLE TOUCH LATCH



- Plastic case.
- Packaged with strike & screws.

ORDER #	FINISH	PKG.	UNIT
514-BL-PWS	BLACK	1	EACH

MAGNETIC DOUBLE TOUCH LATCH



- Plastic case.
- Packaged with strike & screws.

ORDER #	FINISH	PKG.	UNIT
515-BL-PWS	BLACK	1	EACH

BORE IN MAGNETIC TOUCH LATCH



- Plastic case.
- Press fits into 10mm diam hole.
- Strike not included.

ORDER #	FINISH	PKG.	UNIT
512 E	BLACK	1	EACH

MINI TOUCH LATCH

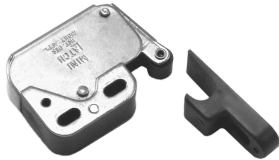

- Steel and plastic case.
- Plastic strike.

ORDER #	FINISH	PKG.	UNIT
505-BP	BRASS	1	EACH
505-NP	NICKEL	1	EACH

FLEXA TOUCH DRAWER OPENER

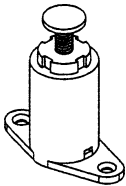

- Allows drawers to be opened by just pushing on the front.
- Adjustable for flush alignment: 2-1/8" to 3".

ORDER #	FINISH	PKG.	UNIT
1021-L-12	WHITE	25	EACH

More cabinet catches available online
at www.thehardwarehut.com



a division of Spokane Hardware Supply, Inc.

HEAVY DUTY MAGNETIC CATCH

IVES

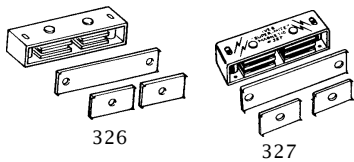

- SP326: Dual double pole.
- SP327: Dual triple pole.
- Self-aligning magnets.
- Steel with aluminum case, 3-1/8" x 1".

ORDER #	FINISH	PKG.	UNIT
326A92	ALUM.	15	EACH
327A92	ALUM.	15	EACH

MAGNETIC DRIVE-IN CATCH

U.S. Futaba, Inc.

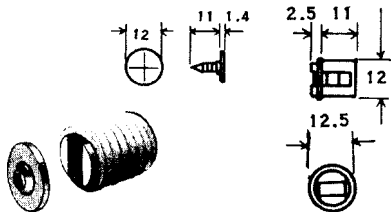

- Mortise type.
- 12mm hole.

ORDER #	DESCRIPTION	PKG.	UNIT
HD180001-BLK	BLACK CATCH	100	EACH
FT50010NP000	STRIKE PLATE	100	EACH

MAGNETIC CATCH PLATE

U.S. Futaba, Inc.

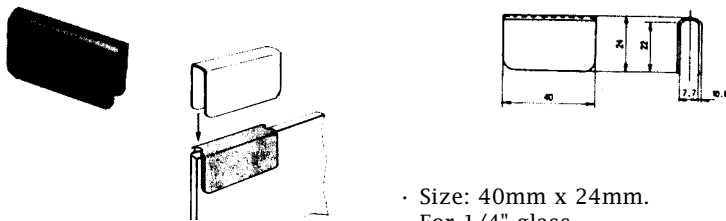

- Size: 40mm x 24mm.
- For 1/4" glass.

ORDER #	FINISH	PKG.	UNIT
K-120 BK	BLACK	100	EACH
K-120 BR	BRASS	100	EACH
K-120 CHR	CHROME	100	EACH

CUPBOARD LATCHES

Cliffside INDUSTRIES, LLC



- Solid brass.
- Base: 2-1/8"H x 1-3/8"W.
- Strike: 2-1/8"H x 9/16"W.
- For cabinets & small doors.
- Packaged with strike & screws.

ORDER #	FINISH	PKG.	UNIT
SBCL-PB	POL. BRASS	1	EACH
SBCL-PC	POL. CHROME	1	EACH
SBCL-SS	SATIN NICKEL	1	EACH
SBCL-FB	FLAT BLACK	1	EACH
SBCL-OA	ANTIQUÉ BRNZ.	1	EACH

ICEBOX CUPBOARD LATCHES

Cliffside INDUSTRIES, LLC

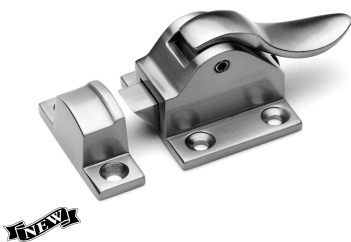

- Solid brass.
- Packaged with strike & screws.
- Latch Base Dimensions
 - Width: 1-3/8in.(35mm)
 - Height: 1-1/2in.(38mm)
 - Projection: 1-1/8in.(29mm)
- Catch Dimensions
 - Width: 1/2in.(13mm)
 - Height: 2in.(51mm)
 - Projection: 5/8in.(16mm)

ORDER #	FINISH	PKG.	UNIT
IBCL-PB	POL. BRASS	1	EACH
IBCL-PN	POL. NICKEL	1	EACH
IBCL-SS	SATIN NICKEL	1	EACH
IBCL-OA	ANTIQUÉ BRNZ.	1	EACH

More cabinet catches available online.

Hardware Hut.com
a division of Spokane Hardware Supply, Inc.

BAR CABINET LATCH

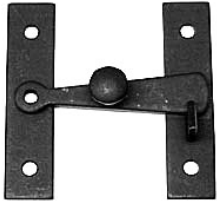

- Smooth black iron finish.
- Length: 2-5/8" (67mm)
- Width: 2-7/16" (62mm)

ORDER #	FINISH	PKG.	UNIT
ALJBR	BLACK	10	EACH

CD5365 CHEST LATCH - CARDED

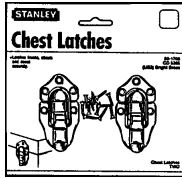

- Size: 2-3/4"
- Brass plated chest latch.
- Securely latches cases, trunks, etc.
- Two per card with screws.

ORDER #	FINISH	PKG.	UNIT
80-1700	US3 BR. BRASS	5	CARD

DRAW CATCHES

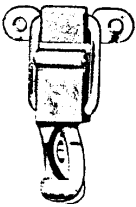

250N

642N

643N

- With locking eyes for use with padlock.
- Steel - zinc plated.
- 250N: 1-5/8" W x 2-15/32" H.
- 642N: 1" W x 3-15/32" H.
- 643N: 1" W x 3-13/16" H.



ORDER #	FINISH	PKG.	UNIT
250N	ZINC	100	EACH
642N	ZINC	25	EACH
643N	ZINC	25	EACH

ADJUSTABLE TENSION BALL CATCHES

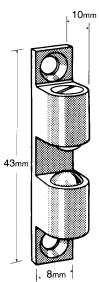

1011

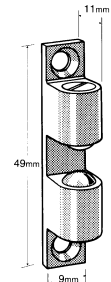

1012

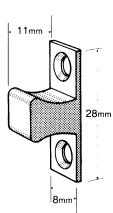

1013

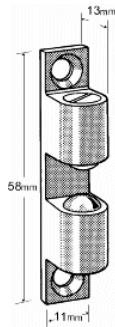

1017



DIMENSIONS

- 1011: 1-11/16"(43mm)H x 5/16"(8mm)W x 13/32"(10mm) proj.
- 1012: 1-15/16"(49mm)H x 3/8"(9mm)W x 7/16"(11mm) proj.
- 1013: 2-5/16"(58mm)H x 7/16"(11mm)W x 1/2"(13mm) proj.
- 1017: 2-3/4"(69mm)H x 1/2"(13mm) x 25/64"(10mm) proj.

- Turn screws to adjust tension.
- Solid brass case.
- Polybagged with screws.



ORDER #	FINISH	PKG.	UNIT
1011-DB	DULL BRASS	1	EACH
1011-DC	DULL CHROME	1	EACH
1012-DB	DULL BRASS	1	EACH
1012-DC	DULL CHROME	1	EACH
1013-DB	DULL BRASS	1	EACH
1013-DC	DULL CHROME	1	EACH
1017-DB	DULL BRASS	1	EACH
1017-DC	DULL CHROME	1	EACH

CD5357 BULLET CATCH - SOLID BRASS



- Size: 3/8".
- Use to give finished touch to cabinet doors.
- Easy to apply.
- Four per card with solid brass fasteners.

ORDER #	FINISH	PKG.	UNIT
80-3850	US3 BR. BRASS	5	CARD

BULLET CATCHES



KNAPE & VOGT

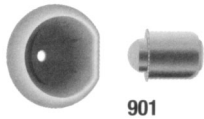

901

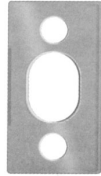

905

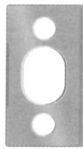

903



- **901:** Varnish proof steel catch with barrel and spring, brass look.
3/8" diam., 1/2" long, 5/8" diam. strike.
- **903:** Adjustable brass look catch.
3/8" diam., 5/8" long, 9/16" x 1-1/16" strike.
- **905:** Adjustable brass look catch.
1/2" diam., 1-1/32" long, 5/8" x 1-1/4" strike.

ORDER #	FINISH	PKG.	UNIT
901 BR DIP	BRASS	100	EACH
903 BR DIP	BRASS	100	EACH
905 BR DIP	BRASS	50	EACH

REV-A-LOCK® SECURITY SYSTEM

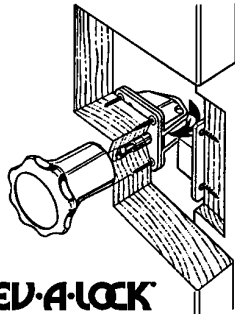

REV-A-LOCK

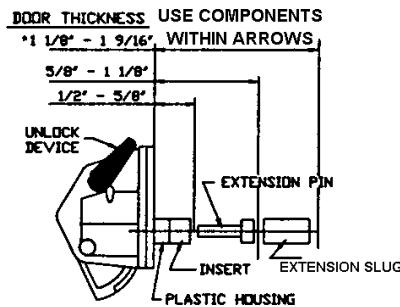

- Only the powerful magnet key can open doors & drawers; standard household magnets won't work.
- All locks are with unlocking bar device & extension slug.
- The lock will install on thicknesses of 1/2" to 1-9/16" and operate through wood, glass, metal, and particle board.
- Magnetic lock & key sold separately.

ORDER #	DESC.	FINISH	PKG.	UNIT
RL-201	LOCK	WHITE	25	SET
RL-202	KEY	WHITE	25	EACH

PLUNGER LOCK

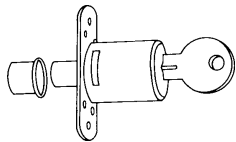

- Barrel: 7/8" (outside diameter).
- Plunger travel: 15/32".
- Plunger Receptacle: 1/2" x 7/16".
- Mounting flange: 7/8" x 2" with screw holes on 1-1/2" centers.
- Keyed alike, non-rekeyable.



KNAPE & VOGT

ORDER #	FINISH	PKG.	UNIT
984KA90	CHROME	12	EACH

RATCHET/SHOW CASE LOCKS

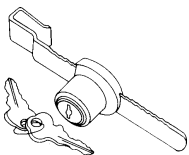

- For 1/4" sliding glass doors.
- Adjustable 3/4" to 3-3/8".
- Keyed alike, non-rekeyable.



KNAPE & VOGT

ORDER #	FINISH	PKG.	UNIT
963KA	CHROME	12	EACH

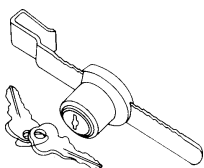

- For doors up to 1/4" thick.
- Keyed alike, non-rekeyable.

Parker Hardware inc. corp.

ORDER #	FINISH	PKG.	UNIT
090 F127	CHROME	10	EACH

NATIONAL CABINET LOCKS

- KA - keyed alike.
- KD - keyed different.
- KD & MK - keyed different and masterkeyed.
- Will key together with other like-tumbler locks.

- Supplied with 2 keys, trim washer, spur washer for wood, mounting nut & 2 cams. 2 stop washers included with multiple application locks.



PIN TUMBLER CYLINDER CAM LOCKS - LIPPED/OVERLAY

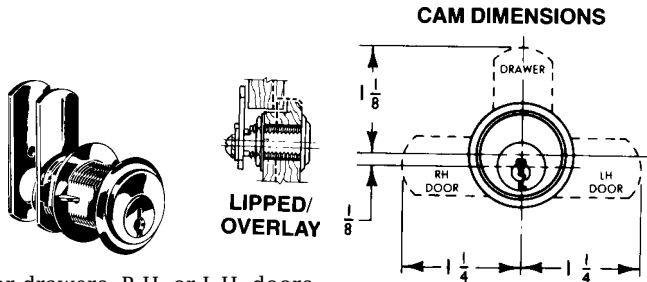

Applications: solid lines show locked position of cam	Position of shifter on back of lock	Applications: solid lines show locked position of cam	Position of shifter on back of lock

- For drawers, R.H. or L.H. doors.
- For lipped or overlay construction. For overlay application, the combined thickness of front and frame cannot exceed the cylinder length.
- 90° cam turn.
- Key is removable in locked and unlocked positions.
- KA, KD.

ORDER #	CYLINDER	MAX. MAT. THICKNESS	FINISH	PKG.	UNIT
C8103-26D KA 915	1-3/16"	7/8"	DULL CHR.	10	EACH
C8103-26D KD	1-3/16"	7/8"	DULL CHR.	10	EACH
C8109-26D KA 915	1-3/4"	1-1/2"	DULL CHR.	10	EACH

- FLUSH

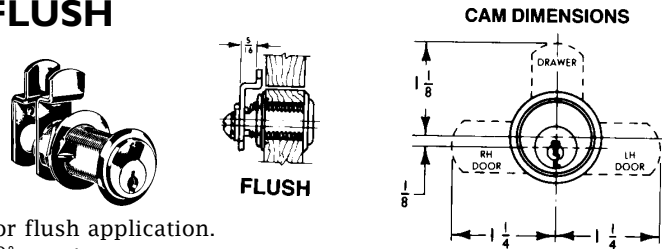

- For flush application.
- 90° cam turn.
- Key is removable in locked and unlocked positions.
- KA, KD.

ORDER #	CYLINDER	MAX. MAT. THICKNESS	FINISH	PKG.	UNIT
C8106-26D KA 915	1-7/16"	1-1/8"	DULL CHR.	10	EACH
C8108-4 KA 915	1-3/4"	1-3/8"	SAT. BRASS	10	EACH
C8108-26D KA 915	1-3/4"	1-3/8"	DULL CHR.	10	EACH
C8108-26D KD	1-3/4"	1-3/8"	DULL CHR.	10	EACH

DISC TUMBLER CYLINDER CAM LOCKS - LIPPED/OVERLAY OR FLUSH

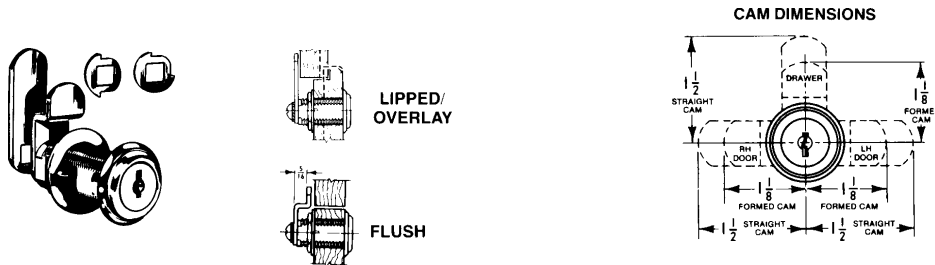

- For drawers, R.H. or L.H. doors with lipped/overlay construction (straight cam) or flush construction (formed cam). For overlay application, the combined thickness of front and frame cannot exceed the cylinder length.
- Either 90° or 180° cam turn.
- Key is removable in locked and unlocked positions.
- KA, KD, KD & MK.

ORDER #	CYLINDER	MAX. MAT. THICKNESS	FINISH	PKG.	UNIT
C8060-3 KA 413A	1-3/4"	1-7/16"	BR. BRASS	25	EACH
C8060-3 KD	1-3/4"	1-7/16"	BR. BRASS	25	EACH
C8060-4G KA 413A	1-3/4"	1-7/16"	ANT. BRASS	25	EACH
C8060-14A KA 413A	1-3/4"	1-7/16"	NICKEL	25	EACH
C8060-14A KD	1-3/4"	1-7/16"	NICKEL	25	EACH
C8060-14A KD & MK	1-3/4"	1-7/16"	NICKEL	25	EACH

NATIONAL CABINET LOCKS

- KA - keyed alike.
- KD - keyed different.
- KD & MK - keyed different and masterkeyed.
- Will key together with other like-tumbler locks.

- Supplied with 2 keys, trim washer, spur washer for wood, mounting nut & 2 cams. 2 stop washers included with multiple application locks.



DISC TUMBLER CYLINDER CAM LOCKS - LIPPED/OVERLAY OR FLUSH

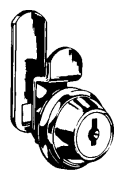

C8051

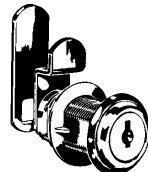

C8053, C8054, C8055

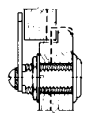

LIPPED/OVERLAY

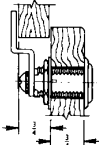

OVERLAY

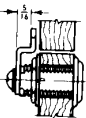

FLUSH

The C8053 lock using the C7014 cam accommodates overlay construction using a 3/4" thick front and 3/4" thick frame. See Page 20 for details.

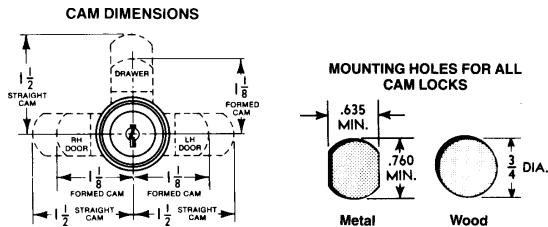

ORDER #	CYLINDER	MAX. MAT. THICKNESS	FINISH	PKG.	UNIT
C8051-14A KA 413A	7/16" L	7/64"	NICKEL	25	EACH
C8051-14A KA 415A	7/16" L	7/64"	NICKEL	25	EACH
C8053-3 KA 413A	1-3/16" L	7/8"	BR. BRASS	25	EACH
C8053-3 KD	1-3/16" L	7/8"	BR. BRASS	25	EACH
C8053-4G KA 413A	1-3/16" L	7/8"	ANT. BRASS	25	EACH
C8053-4G KD	1-3/16" L	7/8"	ANT. BRASS	25	EACH
C8053-14A KA 413A	1-3/16" L	7/8"	NICKEL	25	EACH
C8053-14A KA 415A	1-3/16" L	7/8"	NICKEL	25	EACH
C8053-14A KD	1-3/16" L	7/8"	NICKEL	25	EACH
C8053-14A KD & MK	1-3/16" L	7/8"	NICKEL	25	EACH
C8054-3 KA 413A	15/16" L	5/8"	BR. BRASS	25	EACH
C8054-4G KA 413A	15/16" L	5/8"	ANT. BRASS	25	EACH
C8054-4G KD	15/16" L	5/8"	ANT. BRASS	25	EACH
C8054-14A KA 413A	15/16" L	5/8"	NICKEL	25	EACH
C8055-3 KA 413A	1-7/16" L	1-1/8"	BR. BRASS	25	EACH
C8055-4G KA 413A	1-7/16" L	1-1/8"	ANT. BRASS	25	EACH
C8055-4G KD	1-7/16" L	1-1/8"	ANT. BRASS	25	EACH
C8055-14A KA 413A	1-7/16" L	1-1/8"	NICKEL	25	EACH
C8055-14A KD	1-7/16" L	1-1/8"	NICKEL	25	EACH

- For drawers, R.H. or L.H. doors with lipped/overlay construction (straight cam) or flush construction (formed cam). For overlay application, the combined thickness of front and frame cannot exceed the cylinder length.
- 90° cam turn.
- Key is removable in locked and unlocked positions.
- KA, KD, KD & MK.

CHEST/LID LOCKS

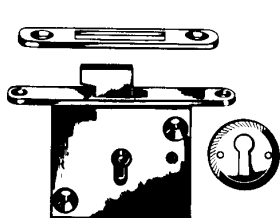

C8384

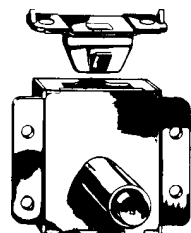

C8414

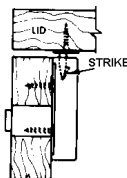
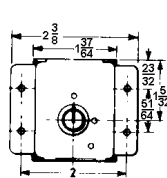
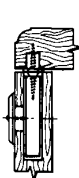
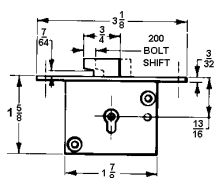

- Lid locks for chest application and other lid locking requirements.
- C8412 is surface mounted & requires a 9/16" dia. cylinder hole.
- C8384 requires 11/32" wide x depth of lock full mortise plus mortise for seldge plus hole for key entry.
- Key removable in both locked and unlocked positions.
- Uses push-button to release lid when lock is used as a latch to keep lid closed, but not locked.
- Each lock is furnished keyed alike; Supplied with one key.
- Appropriate strikes and mounting screws supplied with locks with additional keyhole escutcheon furnished with C8384.



ORDER #	INSTALLATION	CYLINDER LENGTH	BOLT TRAVEL	FINISH	PKG.	UNIT
C8384-3	FULL MORTISE	-	5/16" - .200 SIDE SHIFT	BR. BRASS	25	EACH
C8414-4G	SURFACE MNT.	7/8"	-	ANT. BRASS	25	EACH

NATIONAL CABINET LOCKS



- KA - keyed alike.
 - KD - keyed different.
 - KD & MK - keyed different and masterkeyed.
 - Will key together with with other like-tumbler locks.
- Supplied with two keys, strike & mounting screws.

PIN TUMBLER DOOR LOCKS

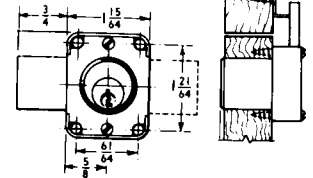
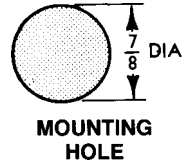
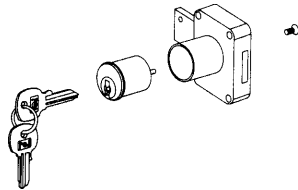
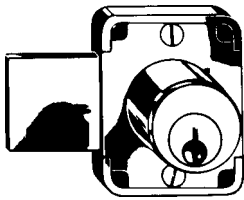

- For R.H. or L.H. doors. Surface mounted.
- Deadbolt-type latch.
- Key is removable in locked and unlocked positions.
- New re-keying feature allows you to remove the cylinder while the lock stays in place. Simply use a 5/64" allen wrench from the back to remove the cylinder & plug for re-keying.
- KA, KD.

ORDER #	CYLINDE	BOLT TRAVEL	FINISH	PKG	UNIT
C8173-4 KA 915	7/8"	3/4"	SAT. BRASS	10	EACH
C8173-26D KA 915	7/8"	3/4"	DULL CHR.	10	EACH
C8173-26D KD	7/8"	3/4"	DULL CHR.	10	EACH
C8175-26D KA 915	1-3/8"	3/4"	DULL CHR.	10	EACH
C8175-26D KD	1-3/8"	3/4"	DULL CHR.	10	EACH

PIN TUMBLER DRAWER LOCKS

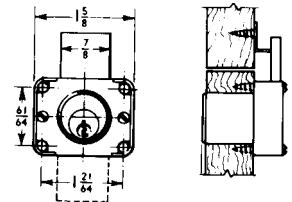
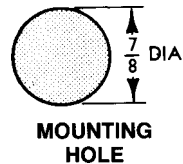
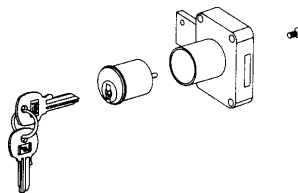
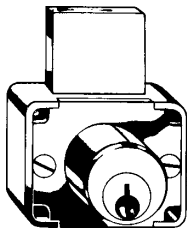

- For drawers. Surface mounted.
- Dead bolt type latch.
- Key is removable in locked and unlocked positions.
- New re-keying feature allows you to remove the cylinder while the lock stays in place. Simply use a 5/64" allen wrench from the back to remove the cylinder & plug for re-keying.
- KA, KD.

ORDER #	CYLINDE	BOLT TRAVEL	FINISH	PKG	UNIT
C8178-4 KA 915	7/8"	3/4"	SAT. BRASS	10	EACH
C8178-4G KA 915	7/8"	3/4"	ANT. BRASS	10	EACH
C8178-26D KA 915	7/8"	3/4"	DULL CHR.	10	EACH
C8179-26D KA 915	1-3/8"	3/4"	DULL CHR.	10	EACH
C8179-26D KD	1-3/8"	3/4"	DULL CHR.	10	EACH

PIN TUMBLER DRAWER LOCK - SPRING LATCH

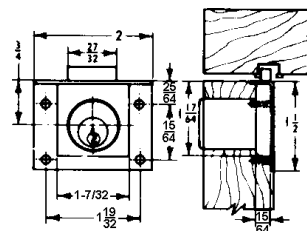
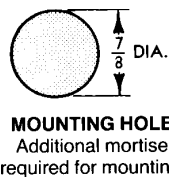

- For drawers.
- Half-mortise type requires mortise for housing.
- Key removable in locked position only.
- KA.

ORDER #	CYLINDE	BOLT TRAVEL	FINISH	PKG.	UNIT
C8131-4 KA 107	7/8"	7/32"	SAT. BRASS	10	EACH

NATIONAL CABINET LOCKS



- KA - keyed alike.
- KD - keyed different.
- KD & MK - keyed different and masterkeyed.
- Will key together with other like-tumbler locks.

· Supplied with two keys and mounting screws.

PIN TUMBLER DRAWER LOCK - DEAD LATCH

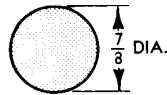
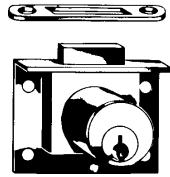

MOUNTING HOLE
Additional mortise required for mounting.

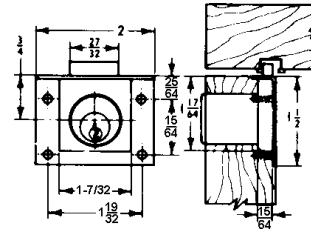

- For drawers.
- Half-mortise type requires mortise for housing.
- Key is removable in locked and unlocked positions.
- KA, KD.

ORDER #	CYLINDER	BOLT TRAVEL	FINISH	PKG.	UNIT
C8133-4 KD	7/8"	1/4"	SAT. BRASS	10	EACH
C8133-26D KD	7/8"	1/4"	DULL CHR.	10	EACH

PIN TUMBLER DRAWER LOCK - DEAD LATCH

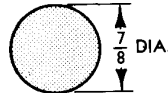
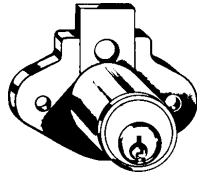

MOUNTING HOLE

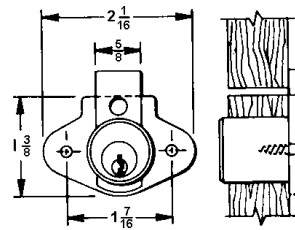

- For drawers. Surface mounted.
- Key is removable in locked and unlocked positions.
- KA, KD.

ORDER #	CYLINDER	BOLT TRAVEL	FINISH	PKG.	UNIT
C8163-4 KA 915	15/16"	11/32"	SAT. BRASS	10	EACH
C8163-26D KA 915	15/16"	11/32"	DULL CHR.	10	EACH

DISC TUMBLER DRAWER LOCK

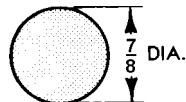

MOUNTING HOLE

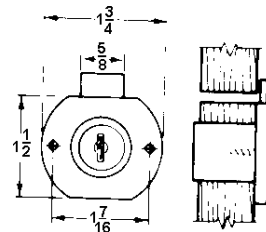

- For drawers. Surface mounted.
- Key is removable in locked and unlocked positions.
- Most keying must be done by the factory, please inquire for details.
- KA, KD, KD & MK.

ORDER #	CYLINDER	BOLT TRAVEL	FINISH	PKG.	UNIT
C8703-3 KA 413A	15/16"	11/32"	BR. BRASS	25	EACH
C8703-3 KD	15/16"	11/32"	BR. BRASS	25	EACH
C8703-4G KA 413A	15/16"	11/32"	ANT. BRASS	25	EACH
C8703-14A KA 413A	15/16"	11/32"	NICKEL	25	EACH

DISC TUMBLER DOOR LOCK

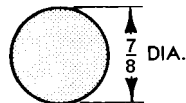

MOUNTING HOLE

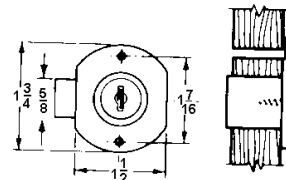

- For doors. Surface mounted.
- Key is removable in locked and unlocked positions.
- Most keying must be done by the factory, please inquire for details.
- KA, KD.

ORDER #	CYLINDER	BOLT TRAVEL	FINISH	PKG.	UNIT
C8704-3 KA 413A	15/16"	11/32"	BR. BRASS	25	EACH
C8704-14A KA 413A	15/16"	11/32"	NICKEL	25	EACH

NATIONAL CABINET LOCKS



- KA - keyed alike.
 - KD - keyed different.
 - KD & MK - keyed different and masterkeyed.
 - Will key together with other like-tumbler locks.
- Supplied with two keys, strike and mounting screws.

PIN TUMBLER SLIDING DOOR, FILE CABINET LOCK - PLUNGER TYPE

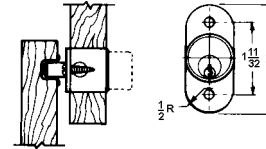
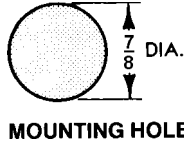
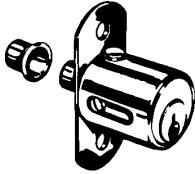

- For wood sliding doors.
- Key is removable in locked and unlocked positions.
- KA, KD.

ORDER #	CYLINDER	BOLT TRAVEL	FINISH	PKG.	UNIT
C8142-26D KD	1-1/8"	7/16"	DULL CHR.	10	EACH

DISC TUMBLER SLIDING DOOR LOCK - 90° TURN HOOK

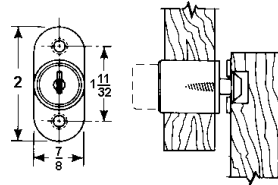
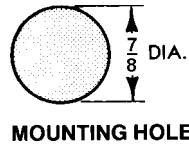
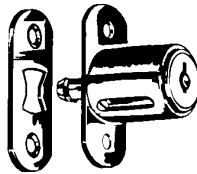

- For wood sliding doors.
- Push-in cylinder, key turn engages bolt behind strike.
- Key is removable in locked and unlocked positions.
- Keying to other locks may have to be done at the factory, please inquire for details.
- KA.

ORDER #	CYLINDER	BOLT TRAVEL	FINISH	PKG.	UNIT
C8042-26D KA 413A	7/8"	7/16"	DULL CHR.	25	EACH

- PLUNGER TYPE

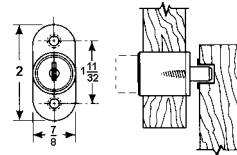
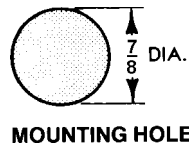
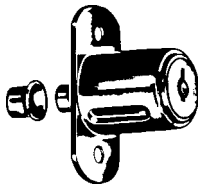

- For wood sliding doors.
- Pushing in cylinder locks doors.
- Key is removable in locked and unlocked positions.
- Keying to other locks may have to be done at the factory, please inquire for details.
- KA.

ORDER #	CYLINDER	BOLT TRAVEL	FINISH	PKG.	UNIT
C8043-26D KA 413A	1"	7/16"	DULL CHR.	25	EACH

More products also available online at
www.thehardwarehut.com



NATIONAL CABINET LOCKS



- KA - keyed alike.
- KD - keyed different.
- KD & MK - keyed different and masterkeyed.
- Will key together with other like-tumbler locks.

· Supplied with two keys, strike and mounting screws.

DISC TUMBLER GANG LOCK



- For locking drawers in desk pedestals and other multiple drawer applications.
- Requires 7/8" dia. hole for cylinder & dado for bar, measuring 7/8" x 1/8" deep on inside of panel.
- Key removable in locked/unlocked positions.
- Turning the key locks all drawers simultaneously (drawers must be in closed position).
- Bar moves studs onto notch in drawer or slide, thus preventing drawer movement.
- Supplied with 2 keys, 3 locking studs, 3 stud sliding, saddle and mounting screws. (Hardware for 3 drawers)
- KA, KD.

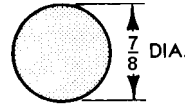

MOUNTING HOLE

Additional 7/8" x 1/8" deep dado for bar required on inside of panel.

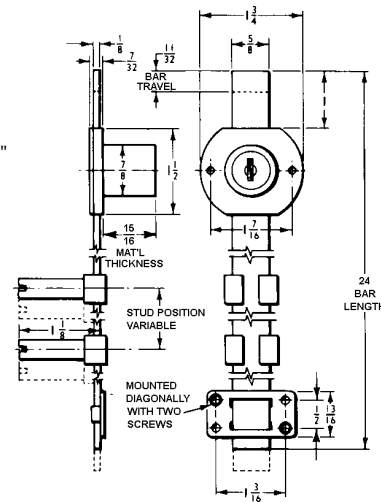

ORDER #	CYLINDER	BAR TRAVEL	FINISH	PKG.	UNIT
D8090-3 KD	15/16"	11/32"	BR. BRASS	5	EACH
D8090-4G KA 413A	15/16"	11/32"	ANT. BRASS	5	EACH
D8090-4G KD	15/16"	11/32"	ANT. BRASS	5	EACH

DualAxess COMBINATION CAM LOCK WITH KEY OVERRIDE

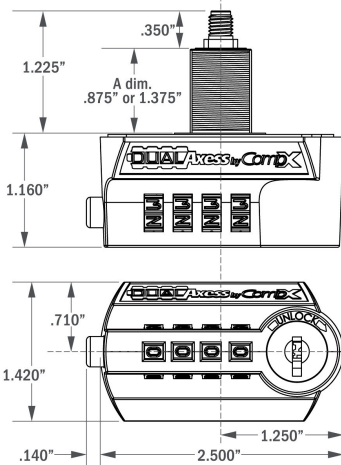

Flush door application

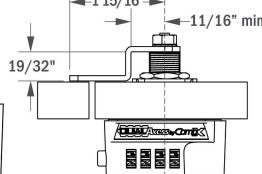

Recommended Hole Location for Door or Drawer Applications

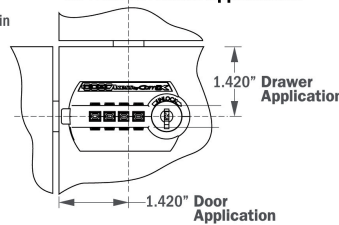

Flush drawer application

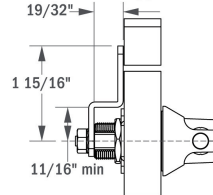

Recommended Mounting Hole Sizes

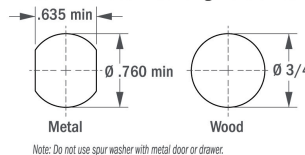

· CompX DualAxess® - an innovative combination cam lock with key override. Access the lock by combination or with a twist of the key. Replaces any standard cam lock to get instant keyless access.

Features Include:

- 10,000 possible code combinations
- Retrofits into existing 3/4" wood or metal mounting holes - no need for drilling or modification.
- Small profile fits most doors & drawers.
- Combinations secure - code can only be changed with the proper key and correct combination.
- Heavy duty die cast construction.
- 100% mechanical - no batteries needed



ORDER #	CYLINDER	MAX. MATERIAL	FINISH	PKG.	UNIT
D8031-19 KA DA120	1-3/8"	1-1/8"	BLACK	10	EACH
D8031-19 KD	1-3/8"	1-1/8"	BLACK	10	EACH
D8772	MASTER KEY FOR DualAxess			1	EACH

DISC TUMBLER CAMS - STRAIGHT

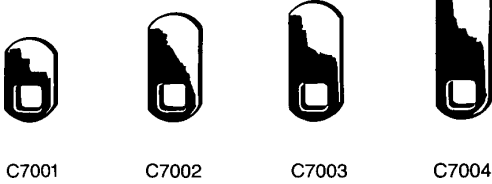

- Straight cams.
- Selection of cams that permit adaption of disc tumbler cylinder cam locks to meet nearly every application need.

ORDER #	LENGTH	FINISH	PKG.	UNIT
C7001-2C	3/4"	ZINC	20	EACH
C7002-2C	1"	ZINC	20	EACH
C7003-2C	1-1/8"	ZINC	20	EACH
C7004-2C	2"	ZINC	20	EACH

- DOUBLE FORMED

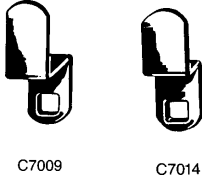

- Double formed cams.
- Selection of cams that permit adaption of disc tumbler cylinder cam locks to meet nearly every application need.

ORDER #	LENGTH	OFFSET	FINISH	PKG.	UNIT
C7009-2C	1-3/4"	1/2"	ZINC	20	EACH
C7014-2C	1-5/8"	5/16"	ZINC	20	EACH

PIN TUMBLER CAMS - STRAIGHT & DOUBLE FORMED

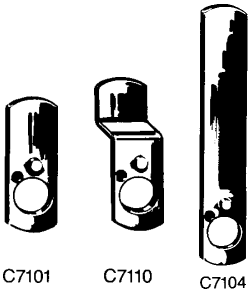

- Cams for pin tumbler cylinder cam locks.
- All cams have dual functions.
- Zinc.

ORDER #	LENGTH	OFFSET	HANDING	PKG.	UNIT
C7101-2C	1-1/4"	-	RIGHT	20	EACH
C7104-2C	3"	-	RIGHT	20	EACH
C7110-2C	1-1/4"	9/32"	RIGHT	20	EACH
C7102-2C	1-1/4"	-	LEFT	20	EACH
C7105-2C	3"	-	LEFT	20	EACH
C7111-2C	1-1/4"	9/32"	LEFT	20	EACH

STRIKES



- Furnished with screws finished to match the strike.

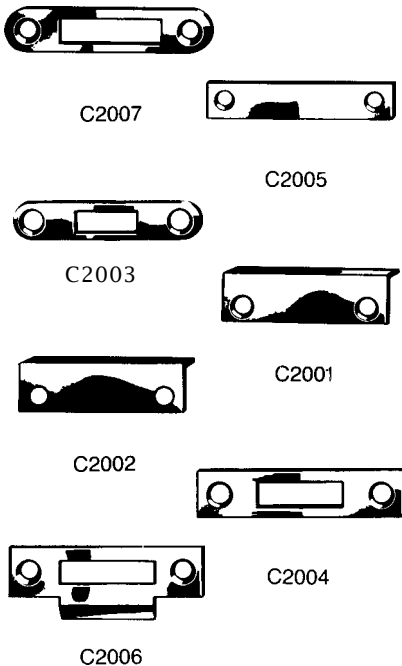

ORDER #	DESCRIPTION	OVERALL DIMENSIONS	FINISH	PKG.	UNIT
C2001-3	FORMED STRIKE, NO BOLT HOLE	1-3/4" x 1/2"	BRASS	25	EACH
C2001-14A	FORMED STRIKE, NO BOLT HOLE	1-3/4" x 1/2"	NICKEL	25	EACH
C2002-3	FORMED STRIKE, NO BOLT HOLE, COUNTERSUNK HOLE REVERSED	1-3/4" x 1/2"	BRASS	25	EACH
C2002-14A	FORMED STRIKE, NO BOLT HOLE, COUNTERSUNK HOLE REVERSED	1-3/4" x 1/2"	NICKEL	25	EACH
C2003-14A	FLAT STRIKE WITH ROUNDED ENDS, 3/4" X 7/32" BOLT HOLE	1-15/16" X 3/8"	NICKEL	25	EACH
C2004-3	FLAT STRIKE W/SQUARE ENDS, 7/8" x 17/64" BOLT HOLE	2-5/32" x 1/2"	BRASS	25	EACH
C2005-3	FLAT STRIKE, NO BOLT HOLE	1-15/16" x 3/8"	BRASS	25	EACH
C2006-3	FLAT STRIKE W/SQUARE ENDS & 15/16" x 1/4" TONGUE, 15/16" x 1/4" HOLE	2" x 3/4"	BRASS	25	EACH
C2006-14A	FLAT STRIKE W/SQUARE ENDS & 15/16" x 1/4" TONGUE, 15/16" x 1/4" HOLE	2" x 3/4"	NICKEL	25	EACH
C2007-3	FLAT STRIKE W/ROUNDED ENDS, 1-1/16" X 17/64" BOLT HOLE	2-5/32" x 1/2"	BRASS	25	EACH
C2007-14A	FLAT STRIKE W/ROUNDED ENDS, 1-1/16" X 17/64" BOLT HOLE	2-5/32" x 1/2"	NICKEL	25	EACH